

TOTALTUB

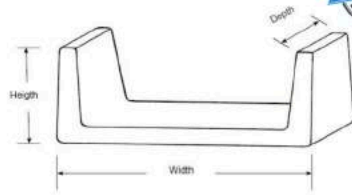

WALK IN TUB CONVERSION & ACCESSIBILITY DEVICES

2017 PRODUCT CATALOGUE

QUICKTUB WALK-THRU TUB INSERTS



- Easier to step into the tub with side wall reduction of approx. 8 in.
- Provides almost 2 ft. of flat area for you to step through.
- Available in various widths to ensure the best possible fit.
- Can be positioned left, right or center of the tub.
- Makes using a tub bench or transfer seat even easier.
- Allows for easier access to caregivers.
- Made from Patented polymer resin.

WLKNRWWH

Narrow Walk-Thru Insert White - Cdn made
28" W x 4 5/8" I.D. (top) x 10" H x 5 5/8"

WLKWIDEWHBA

Wide Walk-Thru Insert White - Cdn made

WLKWIDEGR

Wide Walk-Thru Insert Gray Speckled - Cdn made
28" W x 5 3/4" I.D. (top) x 10" H x 6 3/4"

WLKXLWH

XL Wide Walk-Thru Insert White - USA made
28" W x 8" I.D. (top) x 11 1/2" H x 9 1/4" I.D.

GLUE-EZ

Kimmel GlueEZ

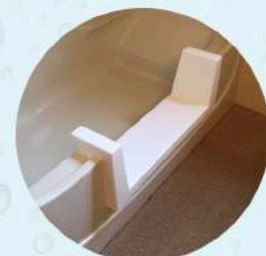
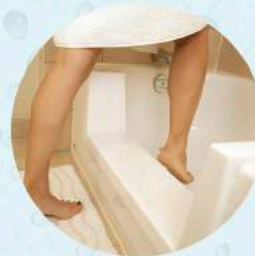

QUICK TUB CAPS

When used with the Walk Thru Insert, the Quick Tub Cap provides a fully functional bathtub.



QTWIDEWH

Wide Quick Tub Cap only - White

QTNRWWH

Narrow Quick Tub Cap only - White

- Installs in seconds
- Patented polymer resin
- Removable and takes up very little space when not in use
- Lightweight – approximately 7¾ lb. (3.5 kg)
- Lifetime seal warranty

Quick
TUB®

MADE IN

CANADA

SIMPLE PROTECTION...

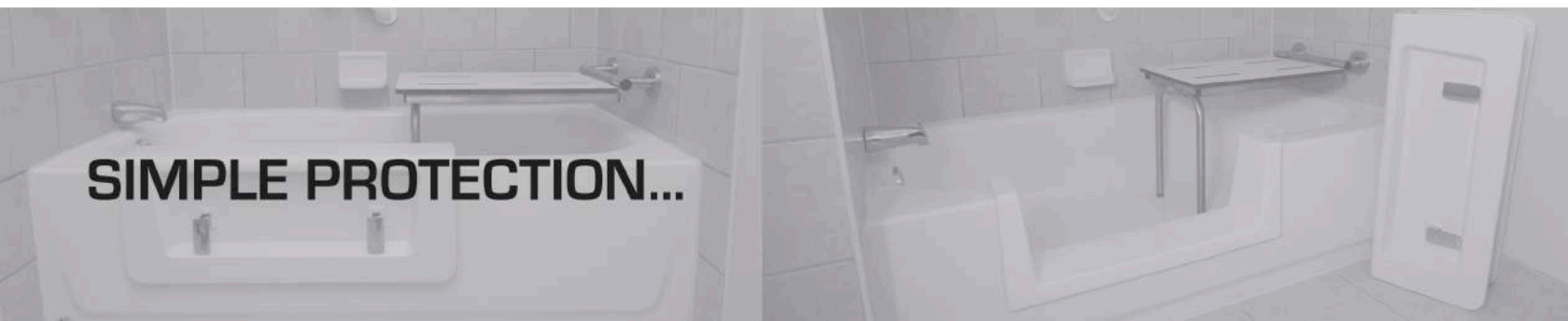

XTRA DEEP WALK-THRU/QUICK TUB CONVERSION KIT

Part # WLKXDKIT

Kit includes 1 Xtra Deep Walk-Thru Tub Insert, 1 Wide Quick Tub Cap, 2 tubes of GlueEZ c/w extension nozzle, 2 Disposable Tub Marking Templates

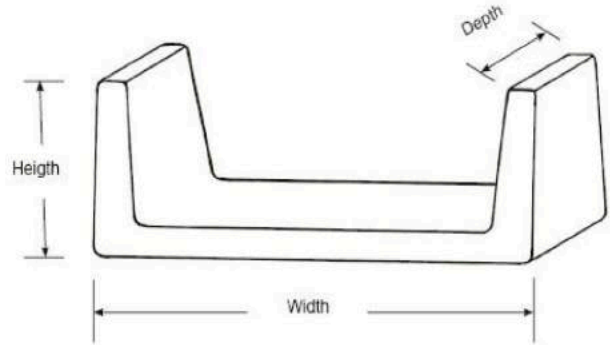
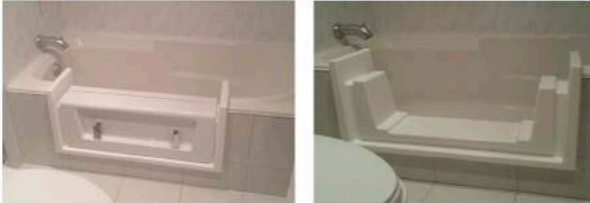

Height - 15.75" Depth - 9.75"

SUREGRIP GRAB BARS STANDARD SERIES GRAB BARS

KNURLED

WGB5SSKN16*

16 inch Standard Satin Finish 308 Stainless Steel 1 1/4 Grab Bar

WGB5SSKN18

18 inch Standard Satin Finish 308 Stainless Steel 1 1/4 Grab Bar

WGB5SSKN24

24 inch Standard Satin Finish 308 Stainless Steel 1 1/4 Grab Bar

WGB5SSKN32

32 inch Standard Satin Finish 308 Stainless Steel 1 1/4 Grab Bar

WGB5SSKN36

36 inch Standard Satin Finish 308 Stainless Steel 1 1/4 Grab Bar



PEENED

*This is a non-stock item Call to check availability

WGB5SSPE12*

12 inch Standard Satin Finish 308 Stainless Steel 1 1/4 Grab Bar

WGB5SSPE16*

16 inch Standard Satin Finish 308 Stainless Steel 1 1/4 Grab Bar

WGB5SSPE18

18 inch Standard Satin Finish 308 Stainless Steel 1 1/4 Grab Bar

WGB5SSPE24

24 inch Standard Satin Finish 308 Stainless Steel 1 1/4 Grab Bar

WGB5SSPE32

32 inch Standard Satin Finish 308 Stainless Steel 1 1/4 Grab Bar

WGB5SSPE36

36 inch Standard Satin Finish 308 Stainless Steel 1 1/4 Grab Bar

SUREGRIP GRAB BARS POLISHED SERIES GRAB BARS

KNURLED

WGB5SSKN16*

16 inch Standard Satin Finish 308 Stainless Steel 1 1/4 Grab Bar

WGB5SSKN18

18 inch Standard Satin Finish 308 Stainless Steel 1 1/4 Grab Bar

WGB5SSKN24

24 inch Standard Satin Finish 308 Stainless Steel 1 1/4 Grab Bar

WGB5SSKN32

32 inch Standard Satin Finish 308 Stainless Steel 1 1/4 Grab Bar

WGB5SSKN36

36 inch Standard Satin Finish 308 Stainless Steel 1 1/4 Grab Bar



PEENED

*This is a non-stock item Call to check availability

WGB5SSPE12*

12 inch Standard Satin Finish 308 Stainless Steel 1 1/4 Grab Bar

WGB5SSPE16*

16 inch Standard Satin Finish 308 Stainless Steel 1 1/4 Grab Bar

WGB5SSPE18

18 inch Standard Satin Finish 308 Stainless Steel 1 1/4 Grab Bar

WGB5SSPE24

24 inch Standard Satin Finish 308 Stainless Steel 1 1/4 Grab Bar

WGB5SSPE32

32 inch Standard Satin Finish 308 Stainless Steel 1 1/4 Grab Bar

WGB5SSPE36

36 inch Standard Satin Finish 308 Stainless Steel 1 1/4 Grab Bar



FROM SLIPS & FALLS

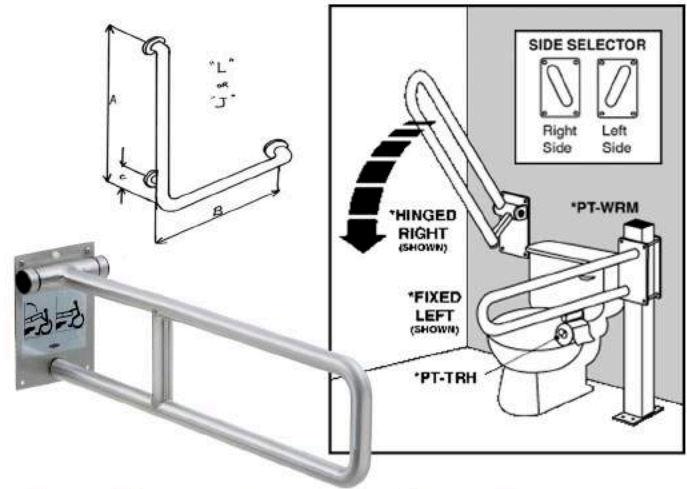

SUREGRIP GRAB BARS

OBC/AODA Compliant grab bars - Made in Canada



WGB5SSKN18OBC

18 inch Standard Satin Finish 308 Stainless Steel 1 1/4 Grab Bar

WGB5SSKN24OBC

24 inch Standard Satin Finish 308 Stainless Steel 1 1/4 Grab Bar

WGB5SSKN32OBC

32 inch Standard Satin Finish 308 Stainless Steel 1 1/4 Grab Bar

WGB5SSKN36OBC

36 inch Standard Satin Finish 308 Stainless Steel 1 1/4 Grab Bar

NOTE - OBC Compliant Grab Bars have 2" Wall Clearance

WGB5SSPE18OBC

18 inch Standard Satin Finish 308 Stainless Steel 1 1/4 Grab Bar

WGB5SSPE24OBC

24 inch Standard Satin Finish 308 Stainless Steel 1 1/4 Grab Bar

WGB5SSPE32OBC

32 inch Standard Satin Finish 308 Stainless Steel 1 1/4 Grab Bar

WGB5SSPE36OBC

36 inch Standard Satin Finish 308 Stainless Steel 1 1/4 Grab Bar



OTHER AVAILABLE GRAB BAR DESIGNS

91024P-TBOBC

24" Towel/Grab Bar, Satin, Peened 308 Stainless Steel, 1 1/4"

91024PP-TBOBC

24" Towel/Grab Bar, Polished, Peened 308 Stainless Steel, 1 1/4"

91024K-TBOBC

24" Towel/Grab Bar, Satin, Knurled, 308 Stainless Steel, 1 1/4"

91024KP-TBOBC

24" Towel/Grab Bar, Polished, Knurled, 308 Stainless Steel, 1 1/4"

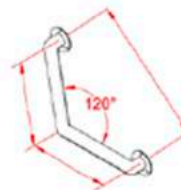
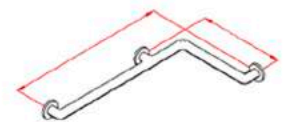
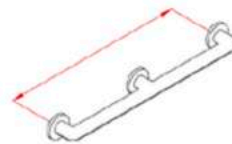

SIMPLE PROTECTION...

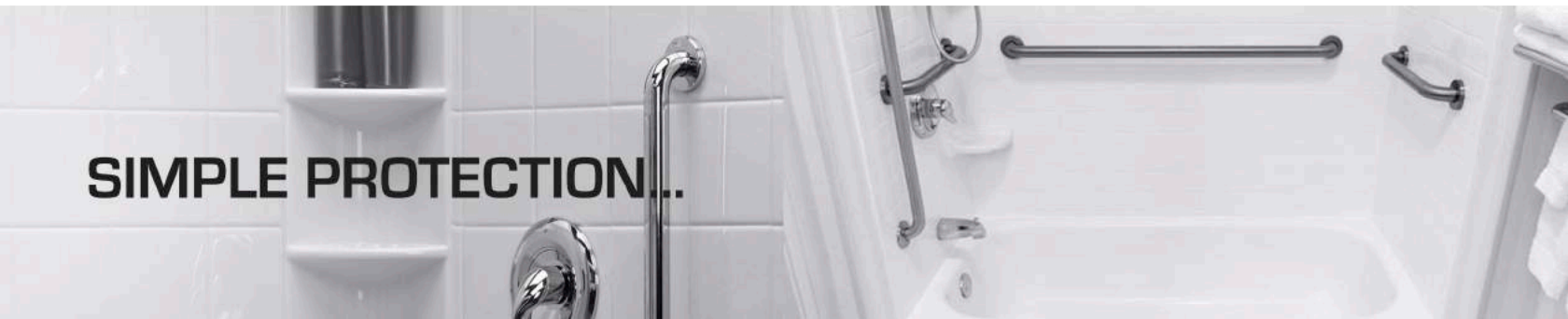

NEW PRODUCT - GRAB BAR/TOILET ROLL HOLDER

Part # WLKXDKIT

C/W Snap-On Flange Covers and 5 Hole Flanges to allow the use of RESGBW35 Winglts

OBC/AODA Compliant

The "P" at the end of the part number will designate "Polished" to a BRIGHT Finish
NOTE - OBC Compliant Grab Bars have 2" Wall Clearance



GRAB BAR/TOILET ROLL HOLDER

PEENED

91060P-TPL18

LEFT SIDE 18" Standard Satin Grip 308 Stainless Steel
1 1/4 Grab Bar

91060P-TPR18

RIGHT SIDE 18" Standard Satin Grip 308 Stainless Steel
1 1/4 Grab Bar

91060P-TPL24

LEFT SIDE 24" Standard Satin Grip 308 Stainless Steel
1 1/4 Grab Bar

91060P-TPR24

RIGHT SIDE 24" Standard Satin Grip 308 Stainless Steel
1 1/4 Grab Bar

KNURLED

91060K-TPL18

LEFT SIDE 18" Standard Satin Grip 308 Stainless Steel
1 1/4 Grab Bar

91060K-TPR18

RIGHT SIDE 18" Standard Satin Grip 308 Stainless Steel
1 1/4 Grab Bar

91060K-TPL24

LEFT SIDE 24" Standard Satin Grip 308 Stainless Steel
1 1/4 Grab Bar

91060K-TPR24

RIGHT SIDE 24" Standard Satin Grip 308 Stainless Steel
1 1/4 Grab Bar

DESIGNER SERIES GRAB BARS



POLISHED STAINLESS STEEL PEENED
1.25" DIAMETER

WGB5PSPE18

18" Bright Hand Polished Peened S/S

WGB5PSPE24

24" Bright Hand Polished Peened S/S

WGB5PSPE32

32" Bright Hand Polished Peened S/S



POLISHED STAINLESS STEEL KNURLED
1.25" DIAMETER

WGB5PSKN18

18" Bright Hand Polished Knurled S/S

WGB5PSKN24

24" Bright Hand Polished Knurled S/S

WGB5PSKN32

32" Bright Hand Polished Knurled S/S



TRUE ELEGANCE 1.5" DIAMETER

WGB6TR16WH

16" True Elegance White

WGB6TR18WH

18" True Elegance White

WGB6TR24WH

24" True Elegance White

WGB6TR30WH

30" True Elegance White



FROM SLIPS & FALLS

TUB BENCHES

CKIMM500-02-001

Tub Bench Folding End Mount Phenolic Split Seat White Slotted without Lift 32 x 16 seat area.
Designed for use on a Fiberglass Tub with a minimum 18" front wall

CKIMM500-04-001

Tub Bench Folding End Mount Phenolic Split Seat White Slotted with 3" Lift 32 x 16 seat area
Designed for use on a metal tub with a **maximum** height 16" front wall



CKIMM500-05-001

Tub Bench Folding One Piece White Phenolic Seat with drop Legs 18" to 20"

CKIMM500-07-001

Tub Bench Folding One Piece White Phenolic Seat with drop Legs 18" to 20"
c/w 3" Tub Lift Extension FOR LEFT HAND DRAIN

CKIMM500-08-001

Tub Bench Folding One Piece White Phenolic Seat with drop Legs 18" to 20"
c/w 3" Tub Lift Extension FOR RIGHT HAND DRAIN

NOTE - The 05, 07 and 08 series of tub benches require that proper measurements be taken so the legs can be adjusted to have the seat in a level position



All of our Shower Seats & Benches are fastened to a wall into proper backing or using our A.O.D.A. Compliant Wall Fasteners. Supports over 500lbs!

SIMPLE PROTECTION...

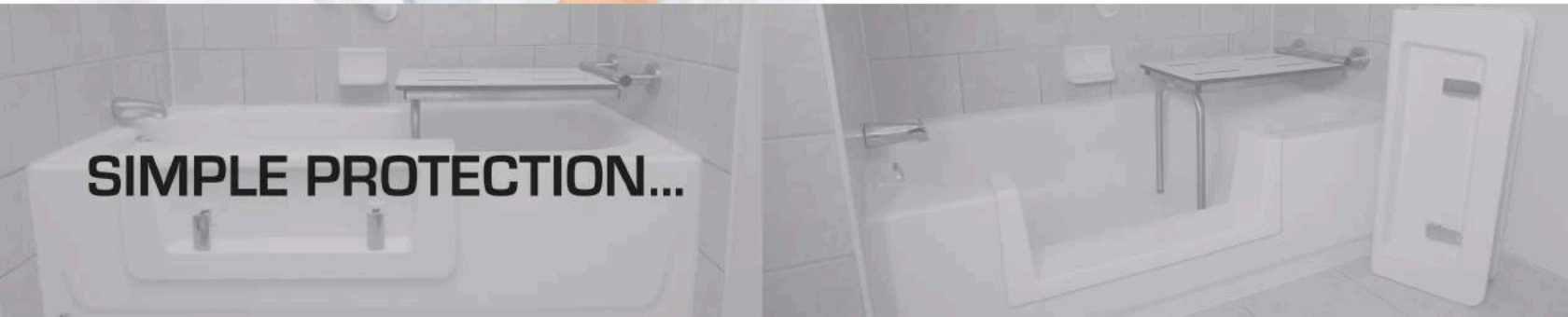

SHOWER SEATS

WSL320225NWR

Shower Seat Extended Folding White Naugahyde
32" wide with an extension out of 22.5" from the wall
Right or Left Side Models



CKIMM500-07-001

Shower Seat Extended Folding White Phenolic Slats 32" x 22.5"
32" wide with an extension out of 22.5" from the wall
Right or Left Side Models



CKIMM500-08-001

Shower Seat Folding White Phenolic Slotted 16" x 24" seat area

FASTENERS & WINGITS

GBW40

WingIt - Standard - use for tub and shower seats



SRGBW40

WingIt - Reverse - use for tub and shower seats



RESGBW35

WingIt - RES - use for grab bars



BAW30

WingIt - Shower Rod & Bath Accessory



MAW35-2P

Master Anchor - 2 per pack

MAW35-24P

Master Anchor - 24 per pack

72186

Solid Mount - 1 kit (shown)



WA200GT54

1 1/4" Apache 200 Carbide Drill Bit

WA200GT34

3/4" Apache 200 Carbide Drill Bit



CERTAINSTEP SURFACE TREATMENT

CSFTT

CertainStep Floor and Tub Treatment - 4 liter jug

CSTN

CertainStep Treatment Neutralizer - 4 liter jug

- After the treatment, the surface is actually safer wet than dry!
- Invisible to the naked eye
- Ready to use within minutes
- Will work on all mineral products such as porcelain, ceramic, limestone, granite, marble, slate, concrete, etc.
- Ideal for commercial applications

CERTAINSTEP SYNGRIT - FLOOR COATINGS

8703

SynGrit HT - High Traffic/ High Gloss

8002

SynGrit Primer High Traffic

78003

SynGrit Garage Grey - needs Grit added

79023-PF / 79023-PM / 79023-PC

SynGrit Fine Grit / SynGrit Medium Grit / SynGrit Course Grit



FROM SLIPS & FALLS

SHOWER CURTAIN RODS STANDARD ARC CURVED CRESCENT SHOWER ROD

- WCRBS5-6
6" Bow 5ft. Bright Stainless Steel Crescent Shower Rod
- WCRBS5-6
9" Bow 5ft. Satin Stainless Steel Crescent Shower Rod
- WCRBS5-6
9" Bow 5ft. White Stainless Steel Crescent Shower Rod
- WCRBS5-6
9" Bow 5ft. Bright Stainless Steel Crescent Shower Rod
- WCRBS5-6
10" Bow 6ft. Bright Stainless Steel Crescent Shower Rod
- WCRBS5-6
10" Bow 6ft. Satin Stainless Steel Crescent Shower Rod



OVAL CRESCENT SHOWER ROD



- WOCBS5-6
6" Bow 5 ft. Bright Stainless Steel Oval Crescent Shower Rod
- WOCNS5-6
6" Bow 5 ft. Satin Nickel Stainless Steel Oval Crescent Shower Rod
- WOCBS5
9" Bow 5 ft. Bright Stainless Steel Oval Crescent Shower Rod
- WOCNS5
9" Bow 5 ft. Satin Nickel Stainless Steel Oval Crescent Shower Rod

Note -
Pivot Brackets & Hardware Pack Included with Each Curved Crescent Rod

CORNER SHOWER CURTAIN RODS (SPECIAL ORDER)



- SR18-L35.532.5
L-Shaped Bright Shower Rod 35.5" x 32.5" c/w
SR-CSJ24
Ceiling Support c/w J-Hook 24" (specify drop)

Please note that ALL shower curtain rods require proper mounting hardware.

COVER PLATES AND SHOWER ROD WINGITS ARE EXTRA

BIG "O" SHOWER CURTAINS



- HBH40E257
Escape Shower Curtain - White c/w snap in/out Liner 71" W x 74" T
- HBH40E258
Escape Shower Curtain - Ivory c/w snap in/out Liner 71" W x 74" T
- HBH40SL0154
Replacement Snap In/Out Liner above 70" W x 54" T
- HBH40PLW01
Plain Weave Shower Curtain - White 71" W x 74" T
- HBH40PLW01X
Plain Weave Shower Curtain - White 71" W x 77" T



SIMPLE PROTECTION...

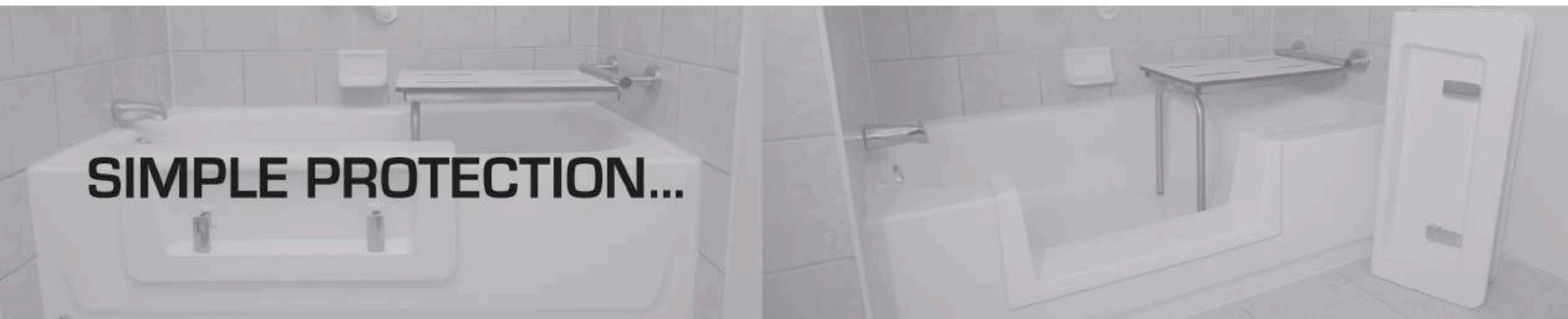

SHOWER CURTAIN RODS
STRAIGHT SHOWER CURTAIN RODS



1375-160
Shower Rod 18 gauge Stainless Steel 60" long 1" Diameter
K100
Straight Compression Shower Curtain Rod - White - 1" Diameter
Expandable from 36" to 72"

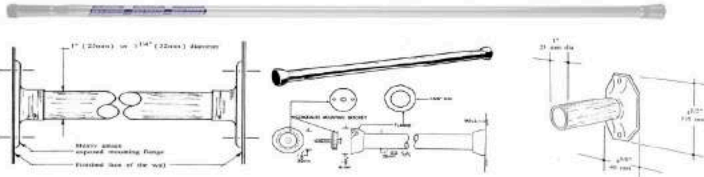

SELECT FLANGE SET

1375SC
Concealed mount plates
Flanges - 1 5/8" (41 mm) diameter
Chrome plated die cast zamark or brass plated
Diecast zamark
1375-001
Chrome plated die cast zamark
1378
Chrome plated die cast zamark
1375-001
Chrome plated die cast zamark

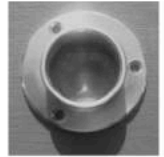

SHOWERHEADS HOSES & BASKETS

6300WBX
Grab Bar Hand Shower Holder - White
K103-42B
Hand Shower (only) White Econo - 2 settings
K010-43B
Hand Shower (only) Chrome - 4 settings
K252-31B
SuperFlex Hose 1.5M - S.S
K254-31B
SuperFlex Hose 2M - S.S
K170-31B
Shower Arm - Chrome
PF14BSCP
Hand Shower Slider Bar - Chrome



WCBPS6
Corner Basket 6" Bright Polished Stainless Steel
WCBNS6
Corner Basket 6" Satin Finish Stainless Steel
WRBPS8
Rectangular Basket 8" Bright Polished Stainless Steel
WRBSN8
Rectangular Basket 8" Satin Stainless Steel
WCB2PS8
2 Level 8" Corner Basket Polished Stainless Steel

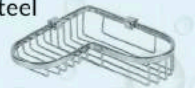

ACCESSORIES



GU-PTB-14
1/4" Carbide Tip Porcelain Drill Bit
GU-PTB-316
3/16" Carbide Tip Porcelain Drill Bit

WLKTEMPWIDE
Wide Walk-Thru Tub Marking Template
WLKTEMPNRW
Narrow Walk-Thru Tub Marking Template
WLKTEMPXL
XL Walk-Thru Tub Marking Template

DS3MMD
Double Sided 3M Mounting Disc -
grab bar waterproof seal

5001
Narrow Walk-Thru Insert Sizing Template
5002
Wide Walk-Thru Insert Sizing Template
5003
XL Walk-Thru Insert Sizing Template



OCP-BS
Bright Rod Plate - Oval Series
OCP-SN
Satin Rod Plate - Oval Series
BCSR-CHM
Bright Rod Plate - Round



FROM SLIPS & FALLS

SWINGCLEAR HINGES

F248-C26D

Std. Duty Swing Clear Hinge - Brushed Nickel - 3 1/2"

F248-C3

Std. Duty Swing Clear Hinge - Bright Brass - 3 1/2"

FBB24841/226D

Med. Duty Swing Clear Hinge - Brushed Nickel - 4 1/2"

FBB24841/2P

Med. Duty Swing Clear Hinge - Paint Primed - 4 1/2"

16H157A

Offshore Expandable Door Hinge - Brass Finish - 3 1/2" (not bright brass)



BOTTOMS UP TOILET LIFT KIT

TV-300

Supplied with wax seals



- Raises your entire toilet by 3 1/2"
- Safer and more stable since you use a conventional toilet seat
- More sanitary and easier to clean than elevated toilet seats
- Universal design - works on round or elongated bowl toilets
- Supports users up to 500 lb (227 kg)
- Compliant with AODA and ADA as well as all building codes
- Patented award winning design

Conventional raised toilet seats that are fastened to the top of the toilet can be highly unstable if not fastened securely. They are also difficult to clean and can prove to be quite unsanitary.

BottomsUp® helps give you independence and restore your dignity. Family members benefit as well; no more separate bathrooms or having to take the raised toilet seat on or off.

TOILET SAFETY BARS

B358OOCA

Toilet Safety Bar Kit



WATER DAMS

TWSG10U

120" Grey c/w 2 sets of Square Corner Kits

TWS5

60" Grey c/w 1 set of Square Corner Kits

TWS10

120" Grey c/w 2 sets of Square Corner Kits

Note - Rounded Corners must be ordered separately

SIMPLE PROTECTION...

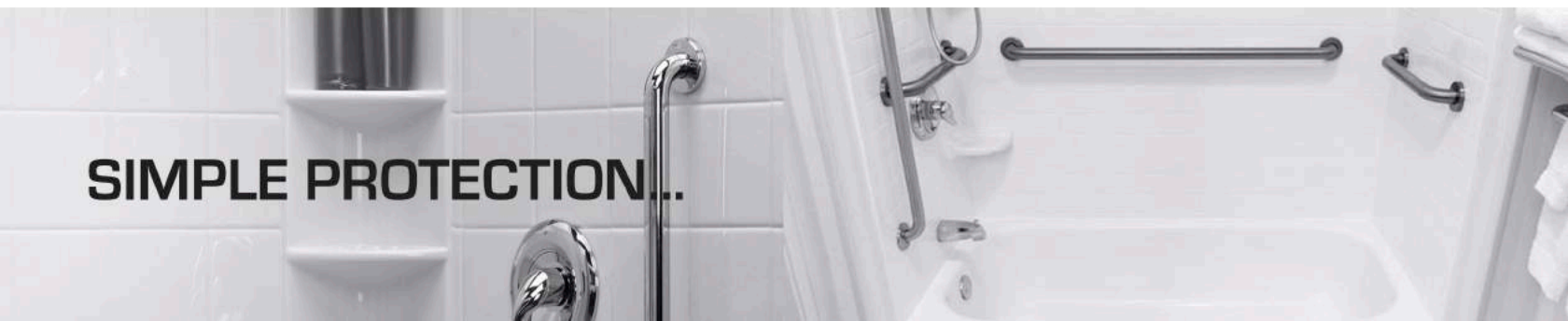

SONARIS BATHLIFT

Great performance at a great price!



Specifications

Seat Size (including side flaps) 20" x 18" x 2.6"
Seat Size (excluding side flaps)
20" x 15" Seat Depth 20" Maximum Seat Height 18"
Minimal Seat Height 2.6"
Baseplate Footprint 21" x 9"
Backrest Size 24" x 14"
Maximum User Weight 375 lbs.
Maximum Recline Angle 40°

0816-21-796—Sonaris2 Bathlift with Seat and Back Covers



Specifications

Seat Size (including side flaps) 19.75" x 28"
Seat Size (excluding side flaps) 19.75" x 14.75" Seat Depth 20"
Maximum Seat Height 18"
Minimal Seat Height 2.6"
Baseplate Footprint 21" x 9"
Backrest Size 26.75" x 13.75"
Maximum User Weight 309 lbs.
Maximum Recline Angle 40°

0816-64-590—Deltis Bathlift with Seat and Back Covers



Accessories

Swivel Seat Supports the turning movement of getting the legs into the bathtub.

Swivel Transfer Seat Serves to turn and slide the body to the center of the lift.



FROM SLIPS & FALLS



SIMPLE PROTECTION FROM SLIPS & FALLS

**WALK IN TUB CONVERSIONS
SWING CLEAR HINGES
SHOWER SEATS & BENCHES
ANTI-SLIP COATINGS
TOILET RISERS & MORE!**

(204) 477-4459

TotalTub is a division of BGP Construction Ltd.

Serving Manitoba for over 20 years.

www.totaltub.com

